

Cable Identifier

EZCI-100



READ THIS MANUAL BEFORE USING THE DEVICE



MADE S.A. with capital of 256 330 €
167, impasse de la Garrigue F 83210 La Farlède
Tél. 33 (0) 494 083 198

GU_EZCI-100_V1_00EN



contact@made-sa.com
www.made-sa.com

SUMMARY

| | | |
|-----------|--|-----------|
| 1. | SAFETY INFORMATION | 4 |
| 1.1. | Safety recommendations..... | 4 |
| 1.2. | Following the safety recommendations | 4 |
| 1.3. | Warning labels..... | 5 |
| 2. | OVERVIEW | 6 |
| 2.1. | Composition | 6 |
| 2.2. | Transmitter front panel | 7 |
| 2.2.1. | Transmitter user interface..... | 8 |
| 2.3. | Receiver front panel..... | 9 |
| 2.3.1. | Receiver user interface | 10 |
| 3. | OPERATING INSTRUCTIONS | 11 |
| 3.1. | Implementation overview..... | 13 |
| 4. | TECHNICAL DATA | 14 |
| 5. | MAINTENANCE, WARRANTY AND COPYRIGHT | 15 |
| 5.1. | Maintenance | 15 |
| 5.2. | Fuses..... | 16 |
| 5.2.1. | Replacing the battery pack protecting fuse..... | 16 |
| 5.2.2. | Replacing the output protecting fuse..... | 17 |
| 5.3. | Batteries..... | 18 |
| 5.3.1. | Replacing the batteries on the transmitter | 18 |
| 5.3.2. | Replacing the battery on the receiver | 19 |
| 5.4. | Warranty..... | 21 |
| 5.5. | Copyright | 21 |

This document is the EZCI-100 User's Guide. It describes the implementation of the device, as well as the different modes of operation to facilitate its use.

1. SAFETY INFORMATION

1.1. Safety recommendations

Please read this guide carefully before unpacking, configuring or using this equipment. Note all indications of danger and other warnings. Failing to observe these recommendations could result in serious injury to the operator or could damage the equipment. To ensure that the protection provided by this equipment is appropriate, do not use or install it other than in accordance with the conditions indicated in this manual.

Dismantling the cases is forbidden. This operation is limited exclusively to personnel qualified by MADE.

1.2. Following the safety recommendations



DANGER: Indicates a dangerous or potentially dangerous situation which, if not avoided, could cause serious or deadly injuries.

WARNING: Indicates a potentially dangerous situation which could cause superficial to moderate injuries.

Remark: Information requiring particular attention.

1.3. Warning labels

Read all labels and wordings shown on the instrument. Injuries or equipment damage could occur if these instructions are not respected.

| | |
|---|---|
|  | Symbol requiring reference to the instruction manual for instructions concerning operation or safety recommendations. |
| IP 54 | IP standard – Protection against dust and water : TRANSMITTER |
| IP 54 | IP standard – Protection against dust and water : RECEIVER |
|  | Do not throw away with household waste |

2.1. Composition



1. Carrying case
2. Transmitter
3. Receiver with sensor
4. Red transmitter cable with integrated fuse
5. Black transmitter cable
6. Red and Black crocodile clips

2.2. Transmitter front panel



1. ON/OFF button: Turn ON and OFF the transmitter

2. Mode button: Switch modulated (PULSE) or continuous (STEADY) mode

3. Level button: Select output level

4. Cable connections: Cable connections to the cable being identified

5. Pulling handle: Pull this handle to extract the transmitter out of the case for maintenance operations.

6. Information display: Visualise all the transmitter settings and status, "Mode" and "Level" settings, "Battery level" and "Output current level" readings.

2.2.1. Transmitter user interface

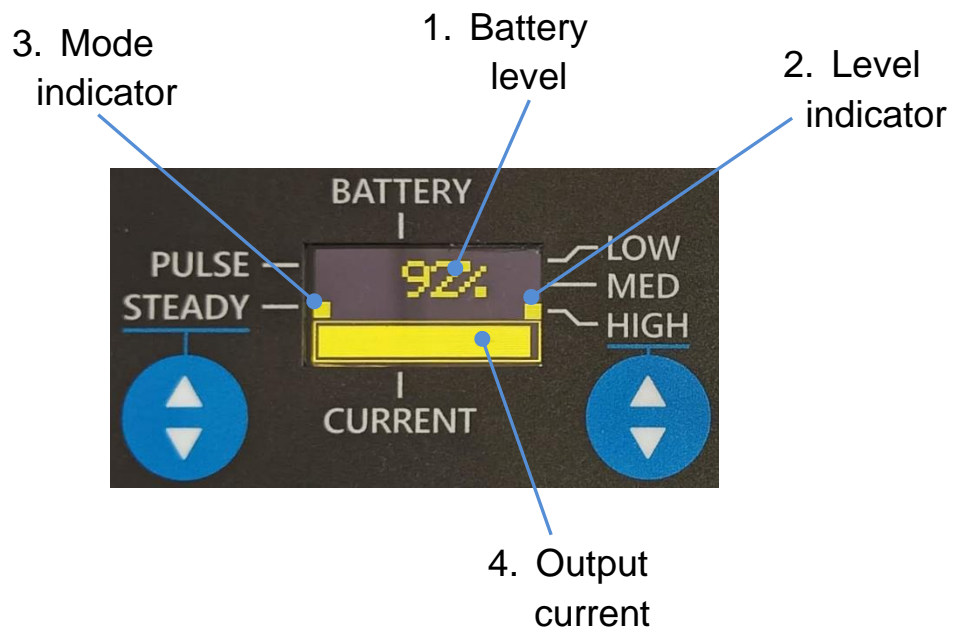

1. Mode indicator: The squared marker align to the mode selected
2. Battery level: Estimated battery level
3. Level indicator: The squared marker align to the level selected
4. Output current: Actual current level being drawn in the cable

2.3.Receiver front panel



1. ON/OFF button: Turn ON and OFF the receiver
2. Sensitivity control: Adjust the sensitivity of the receiver for best identification
3. Filter button: Activate/Deactivate 50/60Hz cutting filter
4. Information display: Visualise all the receiver settings and status, "Filter" setting, "Battery level" and "Input signal strength" readings.

2.3.1. Receiver user interface

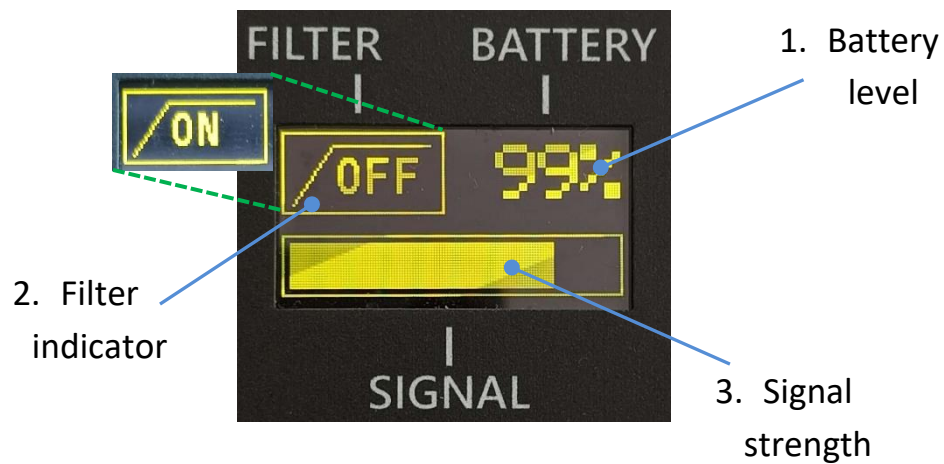

1. Filter indicator: Show current filter status
2. Battery level: Estimated battery level
3. Signal strength: Actual signal strength picked up by the coil sensor.

Remark: The receiver has an internal piezo buzzer that gives an audible indication of the signal being received.

3. OPERATING INSTRUCTIONS

DANGER: ENSURE THAT THE CABLE TO BE IDENTIFIED IS DE-ENERGISED AND ISOLATED BEFORE PROCEEDING.



This equipment **MUST NOT** be connected to live cables. Ensure that all relevant safety procedure are followed and that this equipment is only used by properly trained and authorised personnel.

Short-circuit two healthy cores of the cable to be identified at its remote end. Connect the output leads from the transmitter WG6P to the same cables cores at the near end at the substation switchgear.

Check the transmitter battery condition on the display.

Select either modulated (PULSE mode) or continuous (STEADY mode) output as required and the signal level so that the best deflection is obtained on the digital bar on the display. If no deflection occurs this indicates a likely open circuit in one core or a high resistance path in the circuit under test.

Remark: *On circuits that have highly resistive/inductive path the output power might be limited, producing the same current for all signal levels (LOW, MED, HIGH).*

If possible, check that the signal is being transmitted down the required cable by placing the pick-up coil close to the transmitter against the cable sheath where it leaves the switchgear. Adjust the receiver gain control (SENSITIVITY knob) to ensure that the maximum signal strength is being detected. If necessary, rotate the pick-up coil around the circumference of the cable to the optimum signal position.

Remark: *When adjusting the SENSITIVITY knob, always try to find the knob position where signal strength is best but not saturated. If needed, adjust signal level on the transmitter.*

Proceed to the site where the cable is to be identified and place the pick-up coil of the receiver against the exposed cable. If there is more than one cable exposed, check each cable until one exhibits the characteristic signal from the transmitter as indicated by the digital bar on the display and the audible tone.

Remark: *The transmitted signal may possibly be inducted into cable(s) running adjacent to the cable to which the transmitter is connected. Positive identification can be made by running the pick-up longitudinally along the cable for a length of about 1-2 meters. On the correct cable a distinctive rise and fall of the received signal should be indicated due to the lay and twist of the cable cores.*

The identification technique using the TRG10/6a is a combination of the rise and fall effect caused by the lay of the cable and the relative signal strength which should be greater in the correct cable than any surrounding cables. The rise and fall signal will be found only on the correct cable.

3.1. Implementation overview

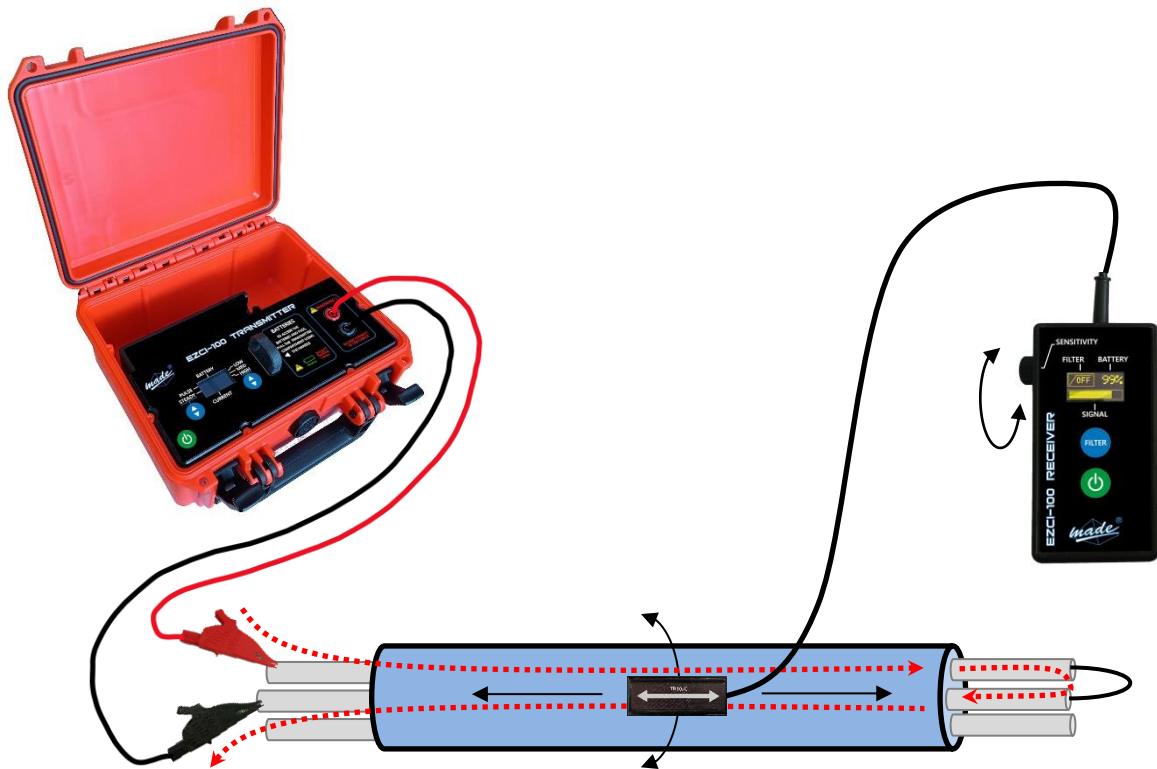

Remark: It is recommended that the transmitter output level be set to “LOW” for most applications to reduce likelihood of induced signal into adjacent cables. Adjustment of the transmitter signal and the gain control on the receiver, together with 50/60Hz assists identification. Always align the “double headed arrow” of the pick-up with the cable.

4. TECHNICAL DATA

| | |
|--------------------|---|
| Dimensions | In carrying case 258 x 243 x 117,5 mm |
| Weight | 2.1 kg |
| Transmitter | |
| Batteries | 8 x MN1400 type C, alkaline manganese (not supplied) 1A fuse for battery protection |
| Output signal | Pulsed or continuous (Low, Medium, High power settings) |
| Visual indicator | 1.28" OLED display indicating: <ul style="list-style-type: none">- Output current (Current flowing through the cable)- Battery level- Output mode (Pulse or Steady)- Output power (Low, Medium or High power settings) |
| Audible indicator | Internal audible signal indicator sounder |
| Receiver | |
| Battery | 1 x 9V MN1604 6LR61, alkaline manganese (not supplied) |
| Pick-up | Connected to receiver with fixed coiled flexible cable approximately 0.7m stretching to 1.5m |
| Visual indicator | 1.28" OLED display indicating: <ul style="list-style-type: none">- Signal received- Battery level- 50/60Hz filter status (ON/OFF) |
| Audible indicator | Internal audible signal indicator sounder |

Markings: UK
CA CE

5. MAINTENANCE, WARRANTY AND COPYRIGHT

5.1. Maintenance



When doing maintenance **ALWAYS** turn off the device before, and **ALWAYS** remove the transmitter off the cables.

Dismantling systems is forbidden. This operation is limited exclusively to personnel qualified by MADE.

Never use solvent, or a solvent-based product, to clean the system and / or its accessories.

For cleaning and maintenance, it is sufficient to:

- Check that the **pick-up** is clean : wipe off with a dry cloth
- Do not use corrosive products to clean the instrument faces
- Use only the accessories delivered with the system
- Follow a training program by a qualified person

5.2. Fuses

The transmitter has two fuses:

- One aside the battery compartment, protecting the battery pack.
- One in the red injection cable, trying to protect the output of the transmitter in case the transmitter has been mistakenly connected to live cables, which **SHOULD NEVER** happen.

5.2.1. Replacing the battery pack protecting fuse



First, pull the transmitter out of the case using the handle.



Then, unscrew the two knurled screws using their knobs and pull the battery compartment out of the transmitter.

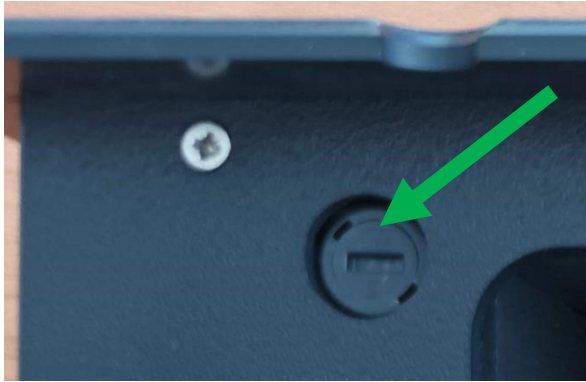

Using a flat head screwdriver, extract the fuse compartment.



Then, replace the fuse by one with the **SAME** characteristics (1A 5 x 20mm Type T 250V) and put all the parts back in following each step in reverse order.

5.2.2. Replacing the output protecting fuse



After removing the clamp from the red protected cable, unscrew the head of the cable.



Then, replace the fuse by one with the **SAME** characteristics (2A 6.3 x 32mm Type F 500V) and put the head back on.

5.3. Batteries

When replacing the batteries of either the transmitter or the receiver:

- **DO NOT** use lithium cell
- Mind the polarity for each cell

5.3.1. Replacing the batteries on the transmitter



First, pull the transmitter out of the case using the handle.

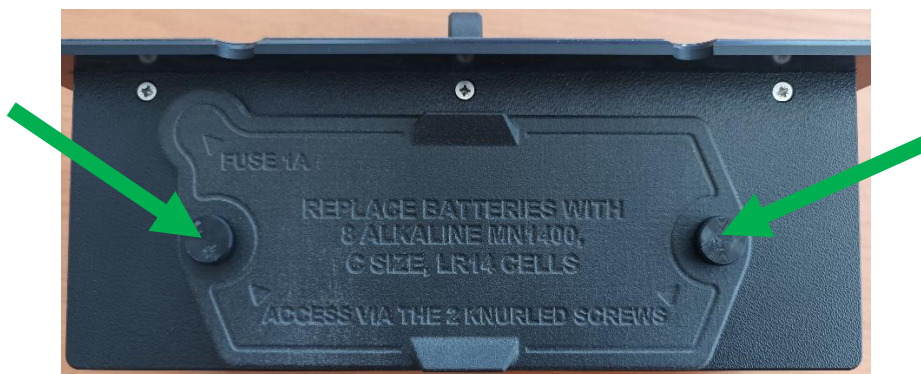

Then, unscrew the two knurled screws using their knobs and pull the battery compartment out of the transmitter.



Finally, replace carefully all the batteries and put all the parts back in following each step in reverse order.

5.3.2. Replacing the battery on the receiver

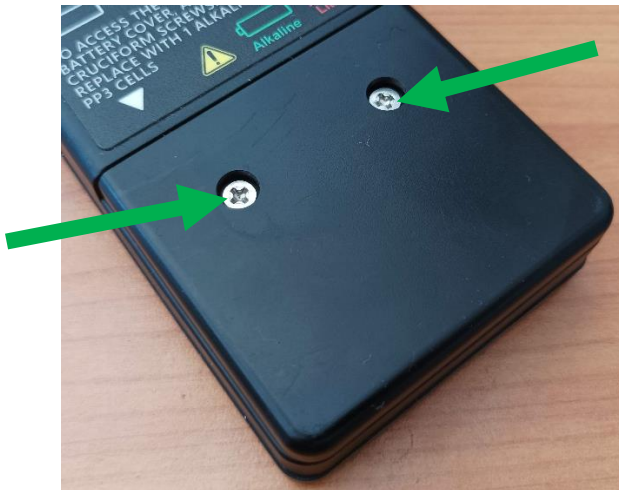

First, unscrew the two Pozidriv M3x8 screws using a Pozidriv PZ1 screwdriver to open the battery compartment.



Then, replace carefully the battery and put all the parts back in following each step in reverse order.

5.4. Warranty

Our warranty and general sales are available and sent by MADE-SA at the customer's request

5.5. Copyright

© All reserved rights. The distribution and the copying of this document, as well as the use and the communication of its content, are forbidden without written authorization of MADE.

The content of this document is destined for use only as information. It can be modified without prior notice and must not be considered as an obligation by MADE.

MADE declines all responsibility for mistakes or inaccuracies that the present document may contain.